



*Rivarossi*

Listino parti staccate per modellisti  
1° Gennaio 1954

RIVAROSSI S.p.A. VIA CONCILIAZIONE 74 - COMO



## LISTINO PARTI STACcate PER MODELLISTI

1 *Rivarossi*

SIGLA	PEZZI PER CONFEZIONE	PREZZI AL PUBBLICO IN LIT. PER CONFEZIONE	DESCRIZIONE
			<u>MOTORI</u>
SFN 734	1	Cad. 2.300	Carrello motore da completare con gli assi con ruote SFN 548 o SFN 549, motore a magnete permanente, funzionamento a 4-12 Volts C.C.
SFN 735	1	" 2.300	Come sopra ma con motore con doppio avvolgimento di campo, funzionamento a 6-16 Volts C.A.
SFN 736	1	" 2.200	Motore montato su cuscinetti a sfere con registro di gioco assiale, albero sporgente con foro filettato per calettamento alla trasmissione. A magnete permanente, funzionamento a 4-12 Volts C.C.
SFN 737	1	" 2.500	Come sopra ma con motore con doppio avvolgimento di campo, funzionamento a 6-16 Volts C.A.
SFN 738	1	" 2.500	Come sopra ma con unico avvolgimento di campo, funzionamento a 4-12 Volts C.C. o C.A. completo di vite senza fine come usato sul 'Minobus'.
SFN 90	12	" Conf. 300/12	Portaspazzola
SFN 740/1	12	" " 300/12	Spazzola con molla premispazzola
SFN 926	100	" " 400/100	Sfere per cuscinetti motori diam. 1 mm.
			N.B. I carrelli motori SFN 734 e SFN 735 sono forniti completi di piastrina con relativa vite per il fissaggio degli assi con ruote.
			<u>TRASFORMATORI E RADDRIZZATORI</u>
SFN 742/A	1	Cad. 2.300	Trasformatore per RT/R, prim. 125 V. sec. 6/15 V. e 15 V.
SFN 742/B	1	" 2.300	Come sopra ma con prim. 155 V.
SFN 742/C	1	" 2.300	Come sopra ma con prim. 220-240 V.
SFN 743/A	1	" 2.600	Trasformatore per RT 100, prim. 125 V. sec. 6/18 V., 18 V. e 32 V.
SFN 743/B	1	" 2.600	Come sopra ma con prim. 155 V.
SFN 743/C	1	" 2.600	Come sopra ma con prim. 220-240 V.
SFN 872	1	" 1.500	Raddrizzatore

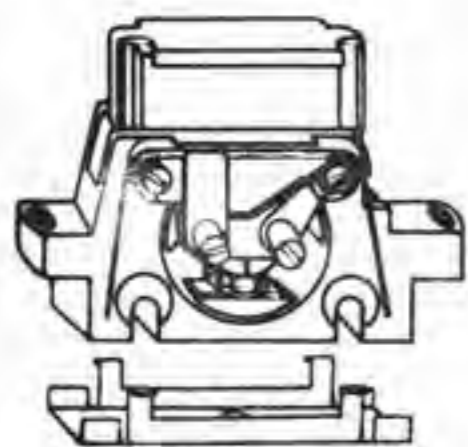

SFN 734

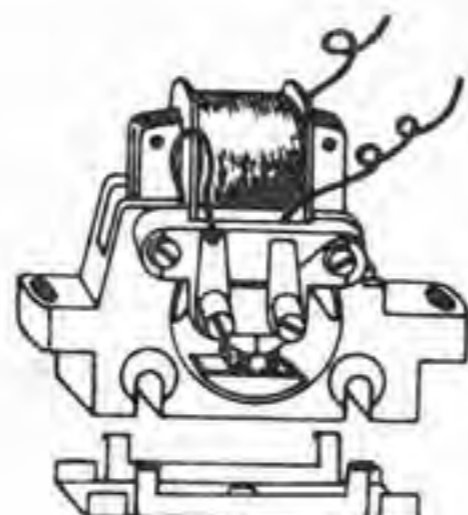

SFN 735



SFN 736



SFN 737



SFN 738



SFN 90



SFN 740/1



SFN 926

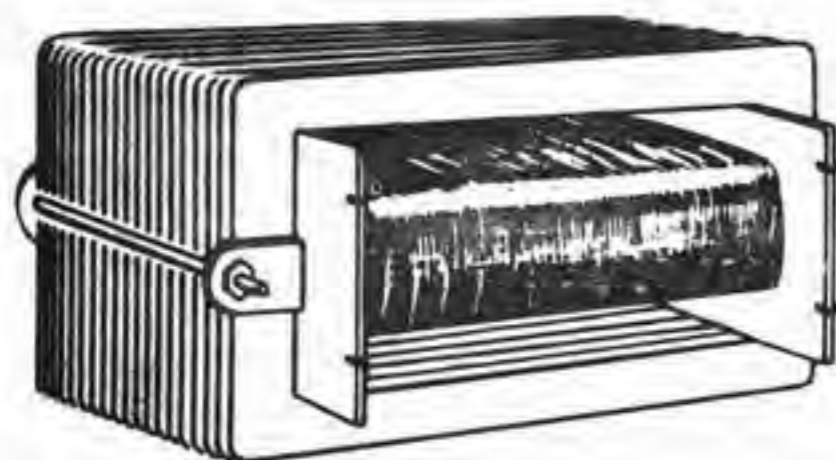

SFN 742/A - B - C

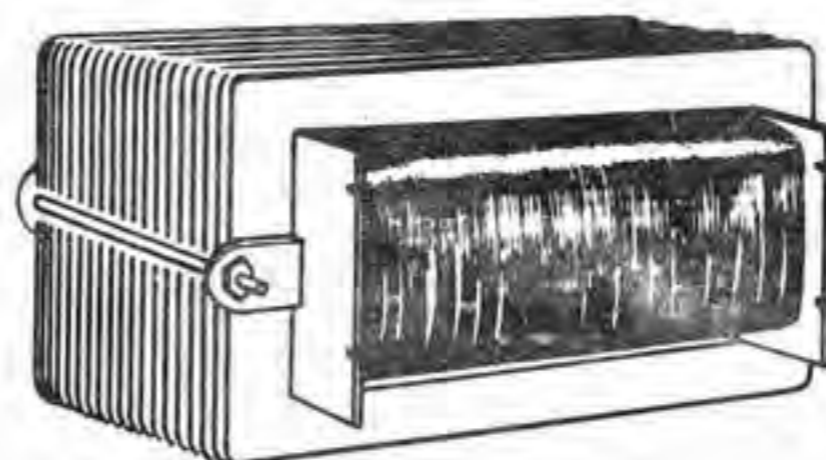

SFN 743/A - B - C



SFN 872



SIGLA	PEZZI PER CONFEZIONE	PREZZI AL PUBBLICO IN LIT. PER CONFEZIONE	DESCRIZIONE
<u>CARROZZERIE - TETTI - TELAI E LORO ACCESSORI</u>			
SFN 305	1	Cad. 2.200	Carrozzeria per A FM
SFN 162	1	" 3.200	" " A 2002 (con pantografi)
SFN 2	1	" 2.200	" " AN 1 e AN 1T
SFN 117	1	" 2.000	" " L 442
SFN 118	1	" 950	" " Tender L 442
SFN 105	1	" 1.100	" " L B&O
SFN 18	1	" 950	" " Le 626 (corpo centrale)
SFN 20	2	" Conf. 900/2	" " Le 626 (musetti)
SFN 493	1	" 2.700	" " Le 424
SFN 566	1	" 1.500	Caldaja con cabina per L 221 e L SP (solo verniciata in nero senza filettature senza corrimano ma forata)
SFN 531	1	" 400	Blocco cilindri per L 221 e L SP
SFN 536	1	" 300	Coperchio camera di fumo per L 221
SFN 591	1	" 300	" " " " " L SP
SFN 533	1	" 350	Piattaforma anteriore per L 221 (senza fanali)
SFN 588	1	" 550	" " " " " L SP
SFN 645/676	1	" 100	Pompa tipo Worthington sinistra e destra per L 221 e L SP
SFN 469	1	" 2.000	Telaio per L 221 e L SP completo di piastrina, zavorra e viti di fissaggio
SFN 793	1	" 400	Albero con vite senza fine con supporti a sfere per L 442, L 221, L SP
SFN 364	6	" Conf. 180/6	Giunto trasmissione
SFN 602	1	" 800	Carcassa tender L 221 e L SP (in tre pezzi, solo verniciata in nero senza filettature e corrimano ma forata)
SFN 605	2	" Conf. 200/2	Coperchio tender L 221 e L SP
SFN 611	2	" " 600/2	Cassone con carbone tender L 221 e L SP
SFN 684	6	" " 480/6	Campanella per L SP con supporto
SFN 582	6	" " 60/6	Fanalino per L 221
SFN 267	1	" 2.300	Telaio per L 442 completo di piastrina e zavorra con relative viti di fissaggio
SFN 19	1	" 550	Telaio per Le 626 completo di portalampada e di commutatore
SFN 594	6	" Conf. 120/6	Gruppo trombe per A FM
SFN 746	24	" " 360/24	Supporto per corrimano
SFN 924	6	" " 90/6	Predellino per locomotiva L B&O
SFN 927	1	" 60	Filo 5/10 per corrimano (1 mt.)
SFN 301	1	" 1.500	Carrozzeria per Minibus

N.B. Tutte le carrozzerie sono fornite già verniciate e provviste di finestrini applicati o casse trasparenti, corrimano ecc. pronte da montare, esclusi i soffietti.

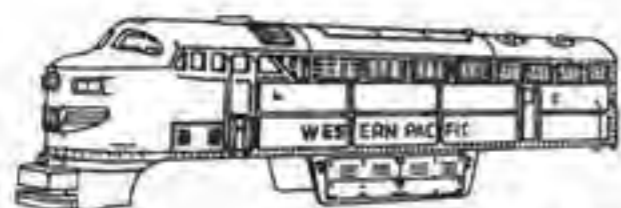

SFN 305



SFN 162



SFN 2

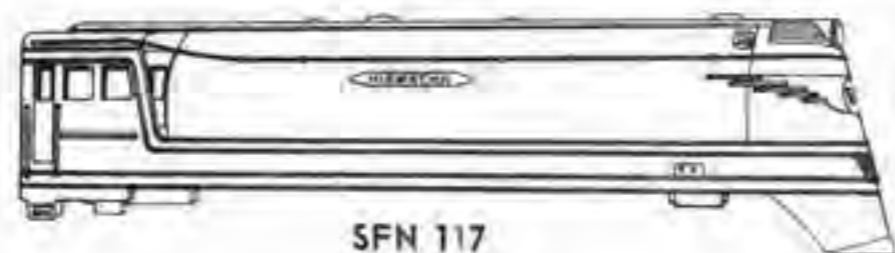

SFN 117



SFN 118

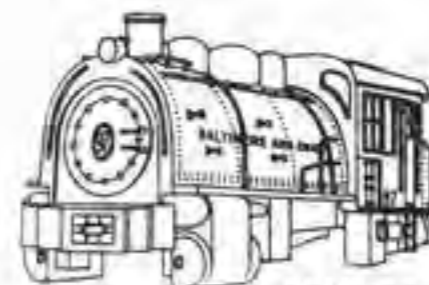

SFN 105



SFN 531

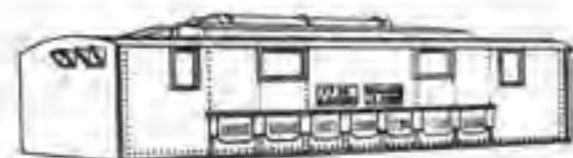

SFN 18



SFN 20



SFN 493

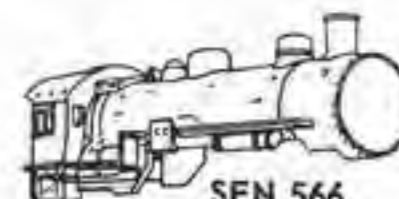

SFN 566



SFN 536



SFN 591

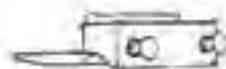

SFN 533



SFN 588



SFN 645/676

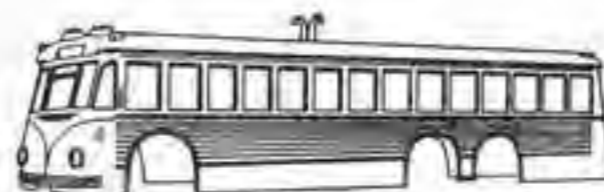

SFN 301

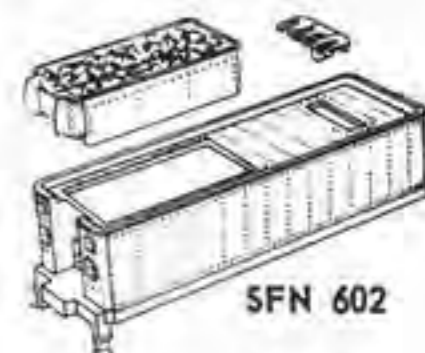

SFN 602

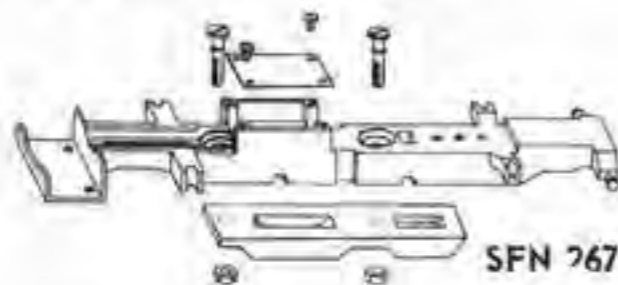

SFN 267

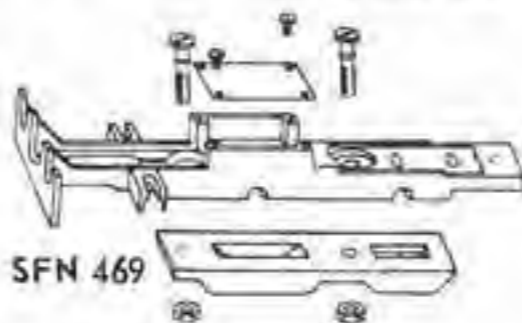

SFN 469



SFN 19



SFN 611

SFN 605



SFN 793

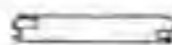

SFN 364



SFN 746



SFN 582



SFN 594



SFN 684



SFN 924



SFN 927

SIGLA	PEZZI PER CONFEZIONE	PREZZI AL PUBBLICO IN LIT. PER CONFEZIONE	DESCRIZIONE
<u>CARROZZERIE - TETTI - TELAI E LORO ACCESSORI</u>			
SFN 50	1	Cad. 1.900	Carrozzeria per V ABz
SFN 51	1	" 1.900	" " V DUz
SFN 528	1	" 1.500	" " V Cz
SFN 529	1	" 1.500	" " V Dz
SFN 745	1	" 2.100	" " V 2002
SFN 140	1	" 1.100	" " V Ciy
SFN 141	1	" 1.100	" " V Di
SFN 395	1	" 200	" " C P
SFN 36	1	" 300	" " C Ltm
SFN 37	1	" 400	" " C Po
SFN 38	1	" 500	" " C F
SFN 142	1	" 350	Tetto per V Ciy e V Di
SFN 39	1	" 250	" " C F
SFN 613	6	" Conf. 600/6	Telaio per carri merce corto
SFN 392	6	" " 720/6	" " " " medio
SFN 599	6	" " 780/6	" " " " lungo
SFN 581	6	" " 1.500/6	" " " " a carrelli
SFN 401	12	" " 180/12	Balestrino per telaio carri merce
SFN 863	12	" " 60/12	Cavallotto di supporto per assi a punte coniche (da applicare sui telai carri merce)
SFN 394	1	" 150	Garitta con piattaforma e vite per carri merce (non verniciata)
SFN 389	6	" 300/6	Soffietto per vagoni in gomma lattice
SFN 354	1	" 180	Scaletta (1 mt.)
SFN 922	6	" Conf. 60/6	Predellino di testa per carri merce
SFN 923	6	" " 120/6	Predellino centrale per carri merce
SFN 928	1	" 360	Catenella per carri merce (1 mt.)



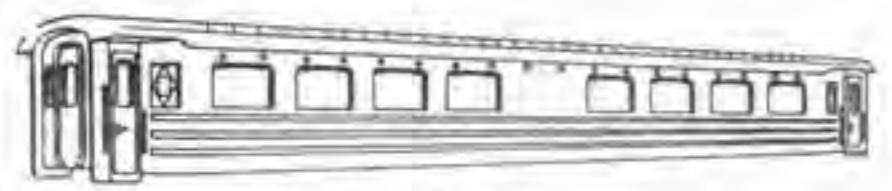

SFN 50

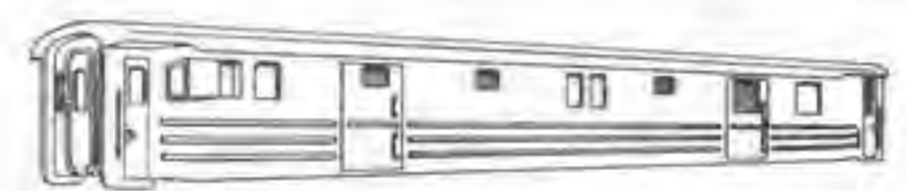

SFN 51



SFN 528



SFN 529

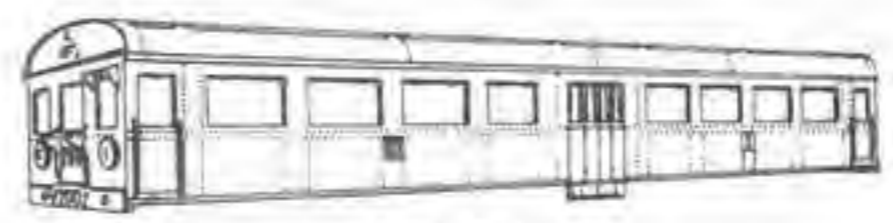

SFN 745

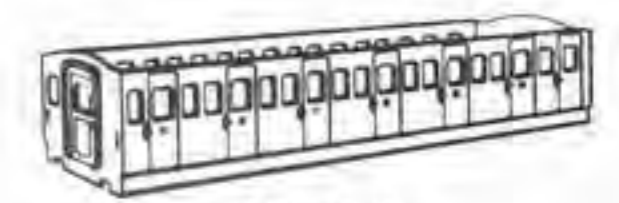

SFN 140

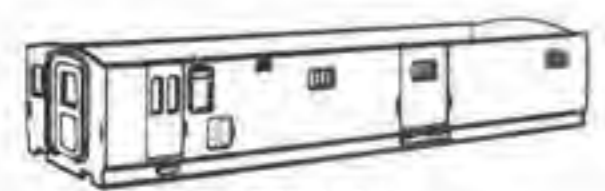

SFN 141



SFN 395



SFN 36



SFN 37



SFN 38



SFN 142

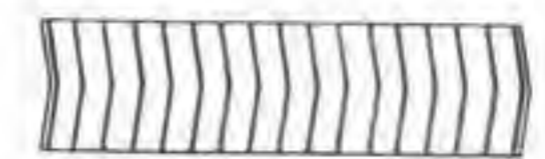

SFN 39



SFN 613



SFN 401



SFN 392



SFN 599



SFN 581



SFN 863



SFN 394



SFN 923



SFN 389



SFN 922



SFN 354



SFN 928

SIGLA	PEZZI PER CONFEZIONE	PREZZI AL PUBBLICO IN LIT. PER CONFEZIONE	DESCRIZIONE
<u>CARRELLI E LORO PARTI</u>			
SFN 979/80	1	Cad. 1.600	Coppia carrelli folli Le 626. Le 626/R completi di ruote e ganci
SFN 626	2	" Conf. 950/2	Carrello tender L 221. L 221/R completo di ruote
SFN 286	1	" 780	Carrello anteriore L 442. L 442/R completo con vite
SFN 981	1	" 460	Carrello anteriore L 221. L 221/R completo con vite e molla
SFN 982	1	" 460	Come sopra ma per L SP. L SP/R
SFN 287	1	" 600	Carrello posteriore L 221. L 221/R. L SP. L SP/R. L 442. L 442/R completo, verniciato in nero
SFN 983	1	" 2.500	Carrello motore per AN 1/R. A 2002/R. A FM/R completo
SFN 984	1	" 1.000	Carrello folle per AN 1/R. A FM/R. A 2002/R. AN 1 T completo
SFN 985	1	" 2.500	Carrello motore per Le 424/R completo
SFN 986	1	" 1.000	Carrello folle per Le 424/R completo
SFN 507	2	" Conf. 800/2	Coppia fiancate carrelli Le 424. Le 424/R con viti di fissaggio (2 coppie)
SFN 498	4	" " 600/4	Fiancata per carrelli A FM. A FM/R con viti di fissaggio (4 pezzi)
SFN 987	4	" " 200/4	Fiancata per carrelli A 2002. A 2002/R (4 pezzi)
SFN 587	2	" " 900/2	Carrello completo per V 2002. V ABz. V DUz con gancio (2 pezzi)
SFN 797	2	" " 1.000/2	Carrello completo per V Cz. V Dz con gancio (2 pezzi)
SFN 573	2	" " 850/2	Carrello molleggiato per carri merce e tender L SP. L SP/R completo di ruote (2 pezzi)
<u>GANCI E LORO MOLLE</u>			
SFN 929	6	Cad. Conf. 300/6	Per vagoni ABz. DUz. 2002. Cz. Dz. con molletta e ribattino
SFN 930	6	" " 300/6	Per carri merce a due assi
SFN 934	12	" " 240/12	Molle per ganci per carri merce corti
SFN 935	12	" " 300/12	Come sopra per carri merce lunghi
<u>RESPINGENTI</u>			
SFN 936/37	12	Cad. Conf. 300/12	Assortiti con testa piatta e tonda, a molla



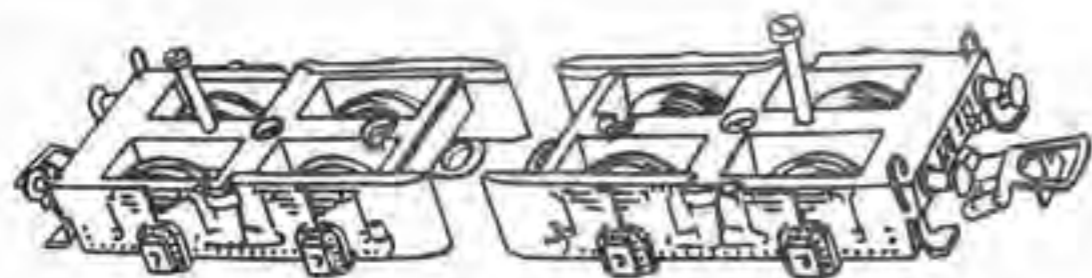

SFN 979/80



SFN 626

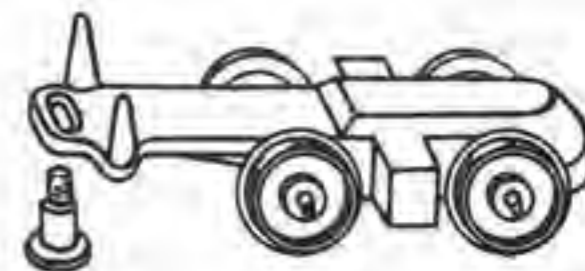

SFN 286



SFN 287



SFN 981



SFN 982



SFN 983



SFN 984

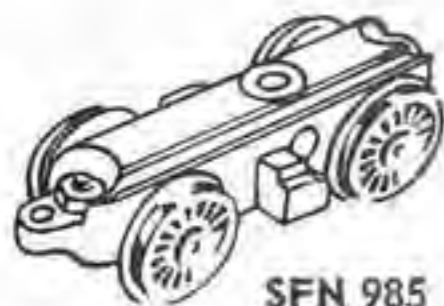

SFN 985

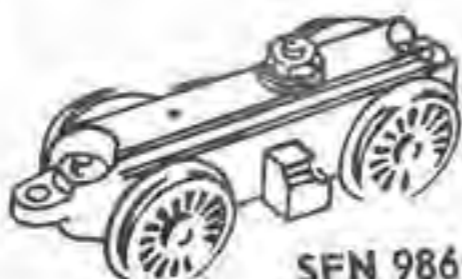

SFN 986



SFN 507

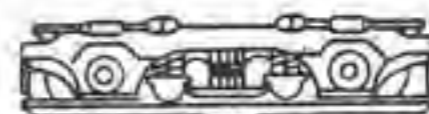

SFN 498



SFN 987

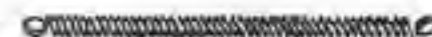

SFN 934 - 935



SFN 587

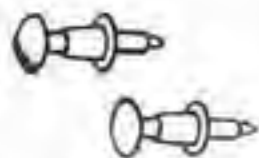

SFN 936 - 937



SFN 573



SFN 797



SFN 929



SFN 930

SIGLA	PEZZI PER CONFEZIONE	PREZZI AL PUBBLICO IN LIT. PER CONFEZIONE	DESCRIZIONE
<u>ASSI CON RUOTE</u>			
SFN 578	6	Cad. Conf. 540/6	Asse con ruote diam. 9 mm. a disco (una ruota isolata)
SFN 546	6	" " 420/6	" " " " 12,5 mm. a disco nere isolate
SFN 920	6	" " 540/6	" " " " 12,5 mm. a raggi rosse (una ruota isolata)
SFN 537	6	" " 660/6	" " " " 15 mm. a raggi rosse (una ruota isolata)
SFN 548	2	" " 320/2	" " " " 18 mm. a raggi rosse con ingranaggio (una ruota isolata) per motori SFN 734, 735
SFN 549	2	" " 350/2	" " " " 18 mm. a raggi nere isolate con portabiella e ingranaggio per motori SFN 734, 735
SFN 827	2	" " 600/2	" " " " 25 mm. nere a raggi isolate con portabiella per L. 442, L. 442/R
SFN 826	2	" " 800/2	Come sopra ma con ruota dentata per vite senza fine
SFN 834	2	" " 500/2	Asse con ruote diam. 25 mm. rosse a raggi isolate con portabiella per L. 221, L. 221/R
SFN 836	2	" " 750/2	Come sopra ma con ruota dentata per vite senza fine
SFN 835	2	" " 500/2	Asse con ruote diam. 25 mm. nere a raggi isolate con portabiella per L. SP, L. SP/R
SFN 832	2	" " 750/2	Come sopra ma con ruota dentata per vite senza fine
SFN 925	6	" " 90/6	Gomme per ruote Minobus
N.B. Gli assi con ruote SFN 578 - 546 - 920 - 537 sono a punte coniche			
<u>DISPOSITIVI PER L' ILLUMINAZIONE</u>			
SFN 1031	6	Cad. Conf. 300/6	Portalampada per lampadine SFN 761 e SFN 760
SFN 761	6	" " 1.200/6	Lampadina 19 V. tipo lilliputh
SFN 760	6	" " 960/6	" 12 V. " "
<u>DISPOSITIVI PER L' INVERSIONE DI MARCIA</u>			
SFN 757	1	Cad. 2.000	Superinversore Rivarossi ' brevettato
SFN 758	1	" 150	Commutatore per inversione di polarita' scatola regolazione



SFN 578



SFN 546



SFN 920



SFN 537



SFN 548



SFN 549



SFN 834 - 836 - 835 - 832



SFN 826 - 827



SFN 925



SFN 760 - 761



SFN 1031

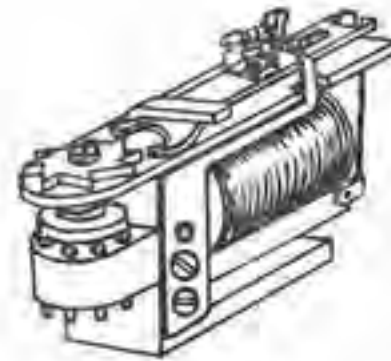

SFN 757

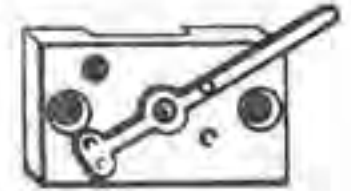

SFN 758



SIGLA	PEZZI PER CONFEZIONE	PREZZI AL PUBBLICO IN LIT. PER CONFEZIONE	DESCRIZIONE
<u>DISPOSITIVI DI CONTATTO</u>			
SFN 26	2	Cad. Conf. 1.000/2	Pantografo
SFN 14	12	" " 240/12	Pattino diritto
SFN 13	6	" " 60/6	Molla pressapattini
SFN 939	6	" " 180/6	Piastrina isolata con molletta prendicorrente per L 442, L 442/R
SFN 940	6	" " 300/6	Pattino a fango completo di vite e dado e isolanti
SFN 640	6	" " 360/6	Supporto biellismo con molletta prendicorrente per L 221, L 221/R, L SP, L SP/R
SFN 941	6	" " 120/6	Molletta prendicorrente per motori SFN 734/35
SFN 942	6	" " 120/6	Capocorda con molletta prendicorrente per detti
SFN 943	1	" " 700	Coppia ste Minobus completa (1 coppia)
<u>MATERIALE ELETTRICO</u>			
SFN 763	6	Cad. Conf. 480/6	Pulsante
SFN 764	6	" " 480/6	Interruttore
SFN 739	1	" " 900	Pulsante per comando inversione di marcia (per RT 100)
SFN 765	1	" " 300	Portalampadina di spia per corto circuiti (per RT 100)
SFN 766	1	" " 400	Portafusibile
SFN 767	6	" Conf. 540/6	Fusibile
SFN 768	6	" " 180/6	Coppia prese unipolari femmine a rosso verde (6 coppie)
SFN 769	6	" " 180/6	Coppia prese unipolari maschio rosso/verde (6 coppie)
SFN 817	6	" " 90/6	Prasa unipolare per L 221, L 221/R, L SP, L SP/R, A FM
SFN 945	1	" " 100	Cordicella unipolare isolata in viola verde (10 mt.)
SFN 946	1	" " 100	" " " " " " rossa (10 mt.)
SFN 447	24	" Conf. 60/24	Rondelle isolanti in fibra 5x2,7x0,5
SFN 947	24	" " 60/24	" " " " " " 7x3,2x0,5
SFN 948	12	" " 60/12	Capocorda per ganci e connessioni elettriche
<u>MOLLE</u>			
SFN 554	12	Cad. Conf. 60/12	Per asse rotazione ABz DUz, V 2002, Cz, Dz
SFN 567	24	" " 120/24	" " " " " " carrelli molloggiati carri merce e tender L 221, L 221/R, L SP, L SP/R
SFN 938	12	" " 60/12	Molla per Superinversore



SFN 26

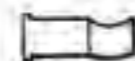

SFN 14

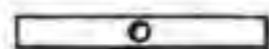

SFN 13



SFN 939



SFN 940



SFN 640



SFN 941



SFN 942



SFN 943



SFN 763



SFN 764



SFN 739



SFN 765



SFN 766



SFN 767



SFN 768



SFN 769



SFN 938



SFN 447  
SFN 947



SFN 945/46



SFN 948



SFN 554



SFN 567



SFN 817

SIGLA	PEZZI PER CONFEZIONE	PREZZI AL PUBBLICO IN LIT. PER CONFEZIONE	DESCRIZIONE
			<u>DADI</u>
SFN 967	12	Cad. Conf. 180/12	4x4 2,6 MA quadro
SFN 968	12	" " 96/12	6 mm. 3 MA esagonale
SFN 969	12	" " 96/12	6 mm. 2,6 MA esagonale
			<u>BIELLISMI</u>
SFN 949	6	Cad. Conf. 60/6	Biella per L B&O e L B&O/V
SFN 950	6	" " 150/6	Biellone con stantuffo per detta
SFN 951	1	" 1.000	Coppia destra-sinistra biellismo completo per L 221, L 221/R, L SP, L SP/R, completa di viti e rondelle distanziatrici (una coppia)
			<u>MATERIALE DI ARMAMENTO</u>
SFN 970	12	Cad. Conf. 1.200/12	Profilato per rotaie in barre di cm. 99 in ferro
SFN 970/OT	12	" " 2.160/12	" " " " " " cm. 99 in ottone
SFN 805	100	" " 500/100	Giunzione per rotaie
SFN 971	12	" " 1.200/12	Striscia di fibra nera con traversine per la posa di binario fisso diritto o curvo
SFN 972	50 gr.	" " 160/50gr.	Chiodini speciali per fissare il profilato per rotaie sulla striscia SFN 971
SFN 973	12	" " 600/12	Filo per linea aerea in barre diritte da 70 cm.
SFN 974	12	" " 1.560/12	Palo 'P' senza basetta
SFN 975	12	" " 2.640/12	Palo 'PM' per Minobus senza basetta
SFN 976	6	" " 600/6	Bobina per il comando elettromagnetico di scambi
SFN 977	6	" " 240/6	Asta di comando per scambi elettromagnetici
SFN 978	2	" " 2.400/2	Segnale a due luci senza lampadine
SFN 586	6	" " 1.080/6	Masselli per sganciamento automatico





SFN 967



SFN 968 SFN 969



SFN 949



SFN 950

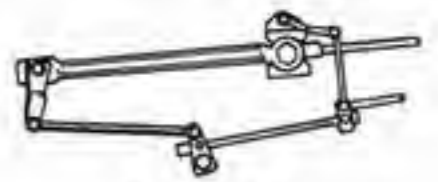

SFN 951



SFN 970 - SFN 970/OT



SFN 805



SFN 971



SFN 972



SFN 973

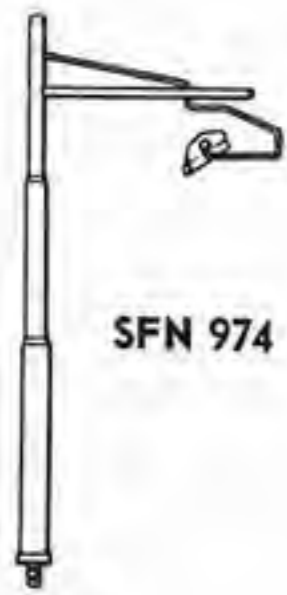

SFN 974

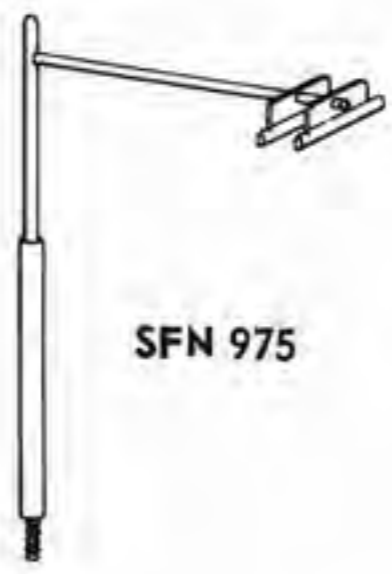

SFN 975



SFN 976



SFN 977



SFN 978

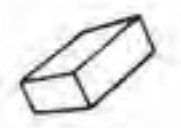

SFN 586

SIGLA	PEZZI PER CONFEZIONE	PREZZI AL PUBBLICO IN LIT. PER CONFEZIONE		DESCRIZIONE
				<u>DECALCOMANIE</u>
DF 988/1	10	Cad. Conf.	100/10	Gialla con scritta ABz
DF 988/2	10	" "	100/10	" " " D'z
DF 989/1	12	" "	120/12	Con scritta Ciy
DF 989/2	12	" "	120/12	" " Di
DF 990	12	" "	120/12	" " FS Italia (gialla)
DF 991	8	" "	80/8	" " Ltm
DF 992	8	" "	80/8	" " Po
DF 993	8	" "	80/8	" " FS Italia (su due righe)
DF 994	8	" "	80/8	" losanga e T orizzontali
DF 995	8	" "	80/8	" T
DF 996/1	7	" "	140/7	" Shell
DF 996/2	10	" "	200/10	" Esso
DF 996/3	10	" "	200/10	" Standard
DF 421/5	8	" "	80/8	" m. 4.00
DF 421/8	8	" "	80/8	" Rev.
DF 422/2	8	" "	80/8	" T e RIV
DF 421/4	8	" "	80/8	" Tolo
DF 421/6	10	" "	100/10	" 10 t.
DF 422/1	12	" "	120/12	" P 657197
DF 1004 1/5	-	" "	300/2	Serie completa iscrizioni per 1 carrozza letto e 1 carrozza ristorante
DF 997	8	" "	240/8	Con Southern Pacific e numero locomotiva
DF 998 1/2	8	" "	200/8	Serie Western Pacific
DF 998/3	8	" "	200/8	Stemma Western Pacific
DF 1002 1/2	10	" "	800/10	Serie The Milwaukee Road con stemma
DF 999	12	" "	120/12	Con FS 221-001
DF 1000	9	" "	90/9	" E 626
DF 1001	8	" "	80/8	" E 424

**ABz**      **DUz**      **CIY**      **Di**      **F.S. Italia**      **Ltm 1922**      **Po 1946**      **F.S. Italia**  
 DF 988/1    DF 988/2    DF 989/1    DF 989/2    DF 990      DF 991      DF 992      DF 993



DF 994

M (8r) 9-11-50  
Tara Kg. 10000

DF 421/4



DF 995



DF 421/6



DF 996/1

Rev M (8r) 9-11 50

DF 421/8



DF 996/2

P 657193 ③

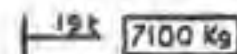

DF 422/1



DF 996/3

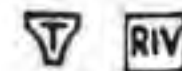

DF 422/2

— m 4.00 —

DF 421/5

FS 221 001

DF 999

.626

DF 1000

€ 424 001

DF 1001

**SOUTHERN PACIFIC LINES**

**3000**

DF 997

THE MILWAUKEE ROAD



DF 1002 1/2

DF 1004 1/5

**WESTERN PACIFIC**

DF 998 1/2



DF 998/3

N. 3964

N. 4348



VOITURE RESTAURANT

VOITURE LITS

DINING CAR

SLEEPING CAR

COMPAGNIE INTERNATIONALE DES WAGONS-LITS ET DES GRANDS EXPRESS EUROPEENS



SIGLA'	PEZZI PER CONFEZIONE	PREZZI AL PUBBLICO IN LIT. PER CONFEZIONE	DESCRIZIONE
			<u>CARTA PER MODELLISTI A COLORI IN FOGLI DI CM. 35X50</u>
SFN 476	12	Cad. Conf. 600/12	Muro di mattoni
SFN 672	12	" " 600/12	Muro di pietre
SFN 673	12	" " 600/12	Muro bugnato
SFN 674	12	" " 600/12	Tetto a lastre di ardesia
SFN 675	12	" " 600/12	Tetto di tegole
SFN 486	12	" " 600/12	Pavimentazione a mattonelle rosse
			<u>SMALTI PER VERNICIATURA</u>
			Smalti speciali asciuganti all'aria da dare sia a pennello sia a spruzzo, forniti in lattine di 1/16 di litro in confezioni di 6 colori assortiti o 6 colori uguali ad eccezione del diluente.
VR 1		Cad. 400	Rosso vivo
VR 2		" 350	Argento
VR 3		" 350	Arancione
VR 4		" 300	Beige isabella
VR 5		" 300	Bruno
VR 6		" 300	Rosso ferro
VR 7		" 300	Azzurro
VR 8		" 300	Bianco opaco
VR 9		" 300	Grigio cenere
VR 10		" 300	Nero
VR T		" 400	Trasparente speciale da dare come mano di fondo su tutte le parti metalliche o di bachelite (non materiale termoplastico)
VR D		" 600	Diluente (1 lattina) speciale per tutti gli smalti, trasparente compreso

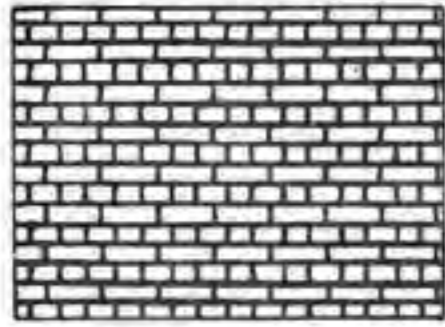

SFN 476

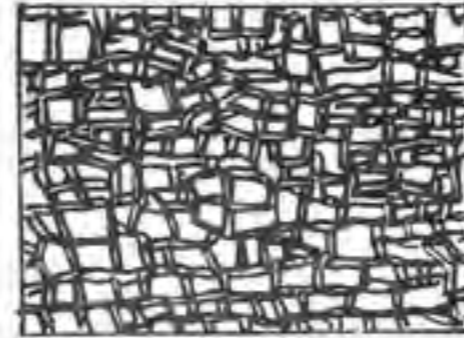

SFN 672



VR 1

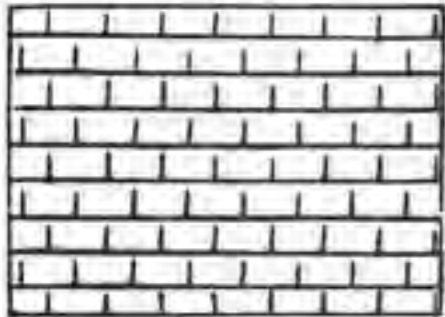

SFN 486

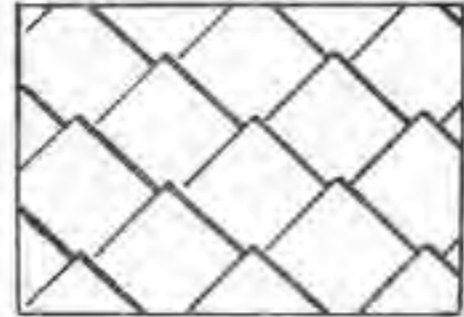

SFN 674

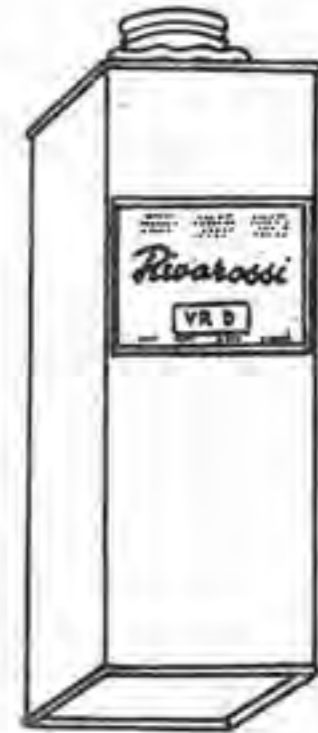

VR D



SFN 675

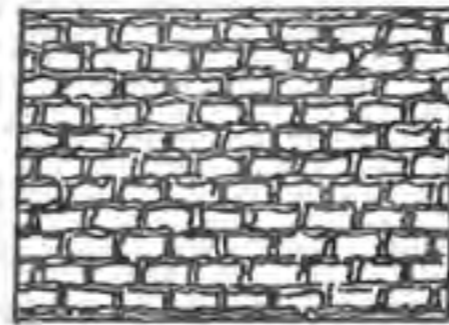

SFN 673

SIGLA	PEZZI PER CONFEZIONE	PREZZI AL PUBBLICO IN LIT. PER CONFEZIONE	DESCRIZIONE
			<u>VITI</u>
SFN 954	12	Cad. Conf. 96/12	2,6x3,5 T.C. fissaggio carrozzeria L B&O, L SP, L 221, fiancate carrelli V ABz, V DUz e fiancate carrelli posteriori L 221, L SP
SFN 789	12	" " 96/12	2,6x6 T.C. fissaggio carrozzeria Le 626
SFN 955	12	" " 120/12	2,6x9 T.C. fissaggio motore L B&O
SFN 956	12	" " 180/12	2,6x40 con collare, fissaggio motore e zavorra Le 626
SFN 462	12	" " 96/12	2,6x3,5 con collare, fissaggio ganci L B&O, Le 626
SFN 670	12	" " 120/12	2,6x5,5 con collare, fissaggio ganci a carrelli AN 1/R, A 2002/R, A FM/R, Le 424/R
SFN 957	12	" " 96/12	2,6x5 T.S. fissaggio carrozzeria L 442
SFN 369	12	" " 96/12	2,6x7 T.S. " " L 221, L SP nel camino
SFN 175	12	" " 96/12	2,6x5 T.S. " carcassa tender L 442 e fondello trasformatori RT/R e RT 100 e piastrina portapattini motore SFN 734, 735
SFN 845	12	" " 120/12	2,6x30 con collare, fissaggio carrelli a tender L 221, L SP
SFN 580	12	" " 96/12	2,6x7 con collare per montaggio carrelli a carri merce
SFN 966	12	" " 180/12	3x10 con collare, vite perno carrelli ABz, DUz, tender L 442
SFN 958	12	" " 120/12	2,6x28 T.C. con collare, fissaggio tetti V Ciy, V Di, C F, C R, e carrelli V Cz, V Dz.
SFN 864	12	" " 120/12	2,6x27 T.C. fissaggio carrozzeria AN 1, AN 1 T
SFN 596	12	" " 120/12	2,6x28 T.C. fissaggio carrozzeria A 2002, V 2002
SFN 693	12	" " 96/12	2,6x3,5 T.S. fissaggio carrozzeria A FM e piastrina carrelli anteriori L 221, L SP, L 442
SFN 703	12	" " 120/12	2,6x25 T.S. fissaggio carrozzeria Le 424
SFN 959	12	" " 180/12	2,6x10 con collare per scatole montaggio carri merce
SFN 960	12	" " 96/12	1,7x3 T.C. per braccio sterzo Minobus e ancoraggio molla carrello posteriore L 221, L SP, L 442 al telaio
SFN 961	12	" " 120/12	Vite perno gruppo rinvio motori SFN 734, 735
SFN 449	12	" " 96/12	Grano calettamento vite senza fine a albero motore SFN 736, 737
SFN 1033	12	" " 96/12	2,6x5,5 T.C. per fissaggio pantografi ed altri molteplici usi
SFN 962	12	" " 120/12	2x4,3 per biellismi a testa esagonale corta
SFN 963	12	" " 120/12	2x5,4 " " " " " media
SFN 964	12	" " 120/12	2x7 " " " " " lunga
SFN 965	12	" " 120/12	2,6x25 T.C. fissaggio carrozzeria Minobus

Leggenda: "T.C." - testa cilindrica  
 "T.S." - testa svasata



LOCOMOTIVA L 835/R			
Sigla	pezzi per confezione	Prezzi al pubblico in Lit. confezione	
SFN 1079/835	1	Cad.	2.200
SFN 740 A	6	• Conf.	300/6
SFN 1089	6	• •	180/6
SFN 1121	6	• •	360/6
SFN 1038	1	•	600
SFN 1034	1	•	900
SFN 1159	1	•	150
SFN 1039	1	•	200
SFN 1158	1	•	900
SFN 1123	2	• Conf.	300/2
SFN 1126	2	• •	250/2
SFN 1125 F	2	• •	250/2
SFN 1045	6	• •	420/6
SFN 1044	12	• •	480/12
SFN 823	6	• •	1.800/6

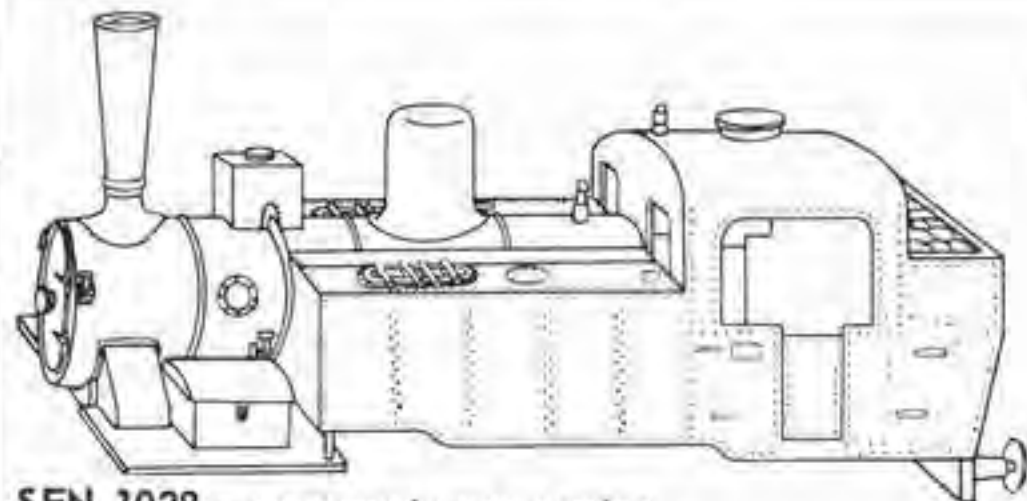

SFN 1038 - carrozzeria con camino

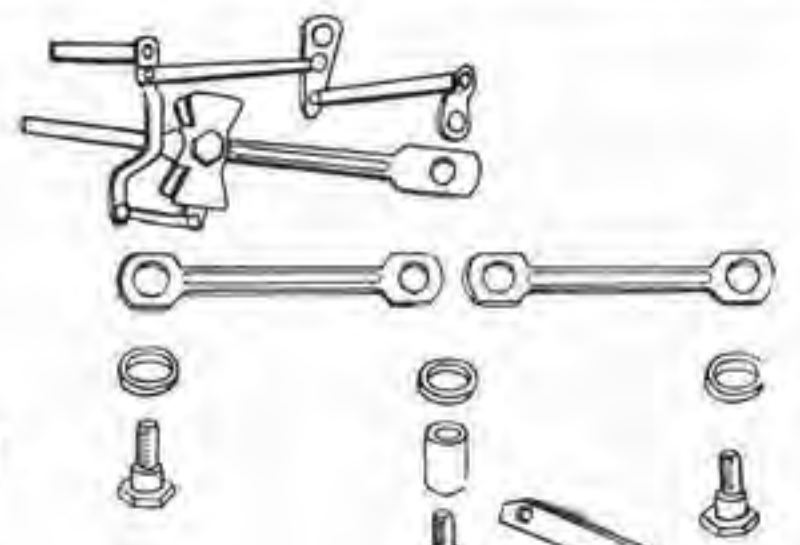

SFN 1079/835 • motore completo di viti senza fine



SFN 1159 zavorra supplementare e vite



SFN 1045 molla presa di corrente con vite

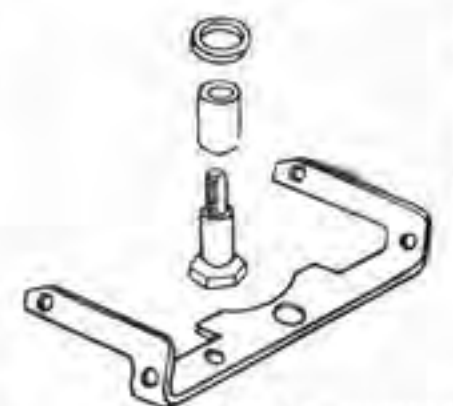

SFN 1158 Biellismo completo destro e sinistro con supporto e viti



SFN 1121 Bussola porta sfere, vite registro e controdado per detto

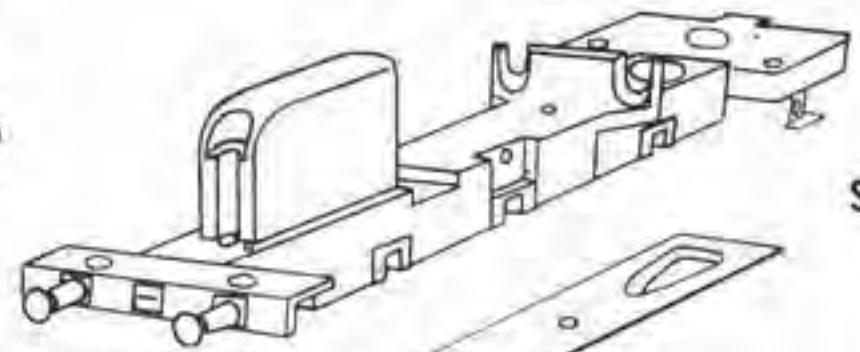

SFN 1034 Telaio completo di viti e piastrina fissaggio

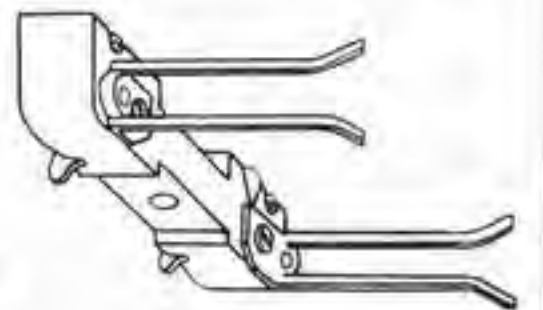

SFN 1039 - Gruppo cilindri con guida per slitta

SFN 1044 Fanale



SFN 823 Lampadina 12 V. Ø 3 mm.



SFN 740 A spazzola rame per motore SFN 1079



SFN 1089 molla per detto

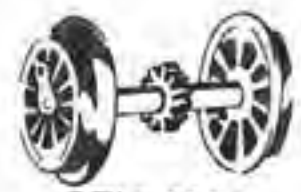

SFN 1123 asse con ruote e ingranaggio Ø 15 mm.

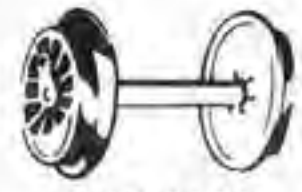

SFN 1126 asse con ruote centrale Ø 15 mm.



SFN 1125R asse con ruote anteriore Ø 15 mm.



## SCAMBI E LORO PARTI

Sigla	pezzi per confezione	Prezzi al pubblico in Lit. per confezione
ECS	2	Cad. Conf. 1500/2
SFN 1070 DS	2	* * 500 la coppia
SFN 1072	6+6+6	* * 300/6 la serie
SFN 721 DS	1+1	* * 520 la coppia
SFN 1096/R	12	* * 180/12
SFN 1096/V	12	* * 180/12
SFN 1102/R	12	* * 180/12
SFN 1102/V	12	* * 180/12
SFN 831	6	* * 900/6

**ECS**

Dispositivo completo per comando elettromagnetico scambi con viti di fissaggio

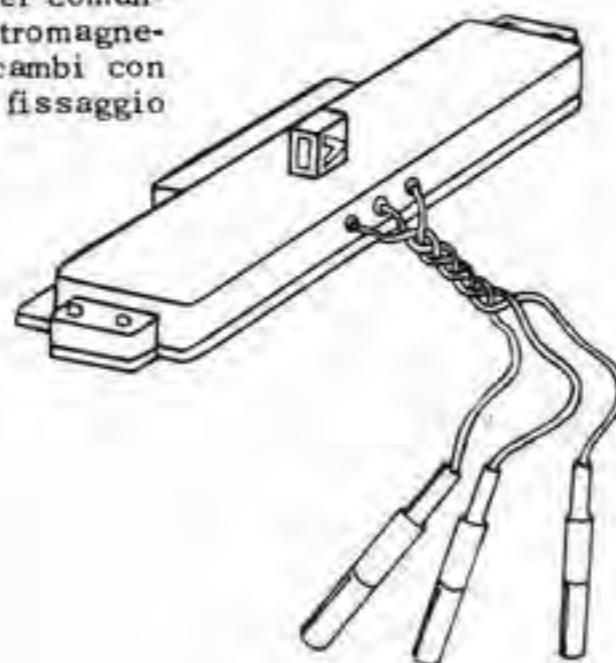
**SFN 831**

Fondello con braccio a molla per dispositivo ECS

**SFN 1072**

Dispositivo per comando a mano scambi

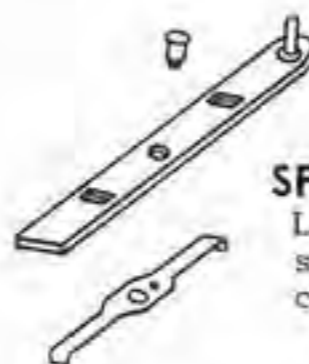
**SFN 1072**

Levetta isolata comando scambi ribattino e molla contatto

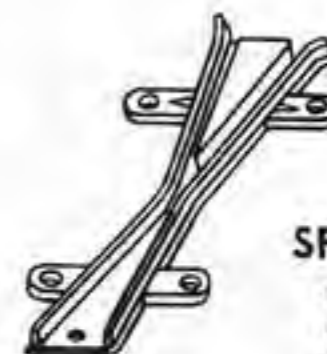
**SFN 721 D/S**

cuore scambio destro e sinistro.

**SFN 1102/R/V**

Riduzione  $\varnothing$  4 mm.  $\varnothing$  2,5 mm. per SFN 1096 rosso-verde.

**SFN 1096 R/V**

presa unipolare rosso-verde  $\varnothing$  2,5 mm.

## TETTI, PORTE E FINESTRE

SFN 915 - Tetto a 4 falde mis. 185x95 mm.

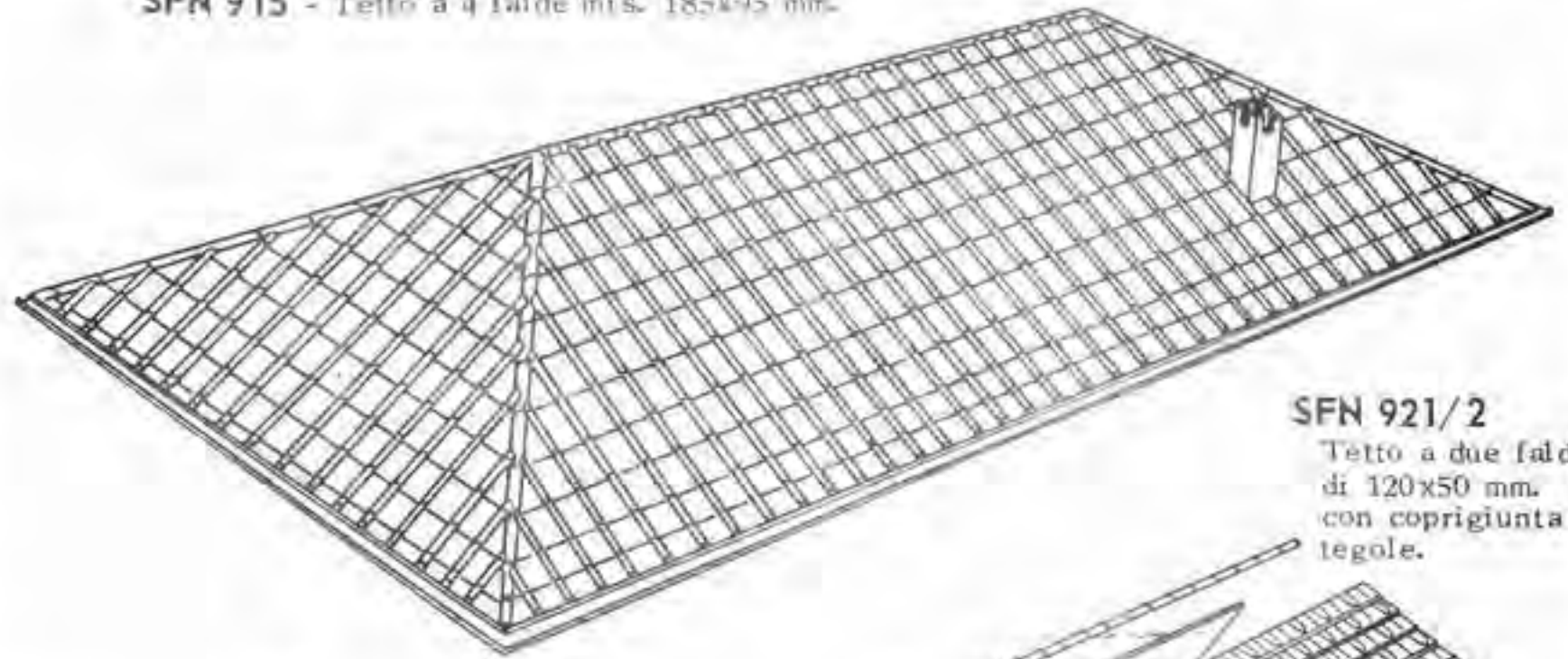

SFN 921/2

Tetto a due falde di 120x50 mm. con coprigiunta a tegole.

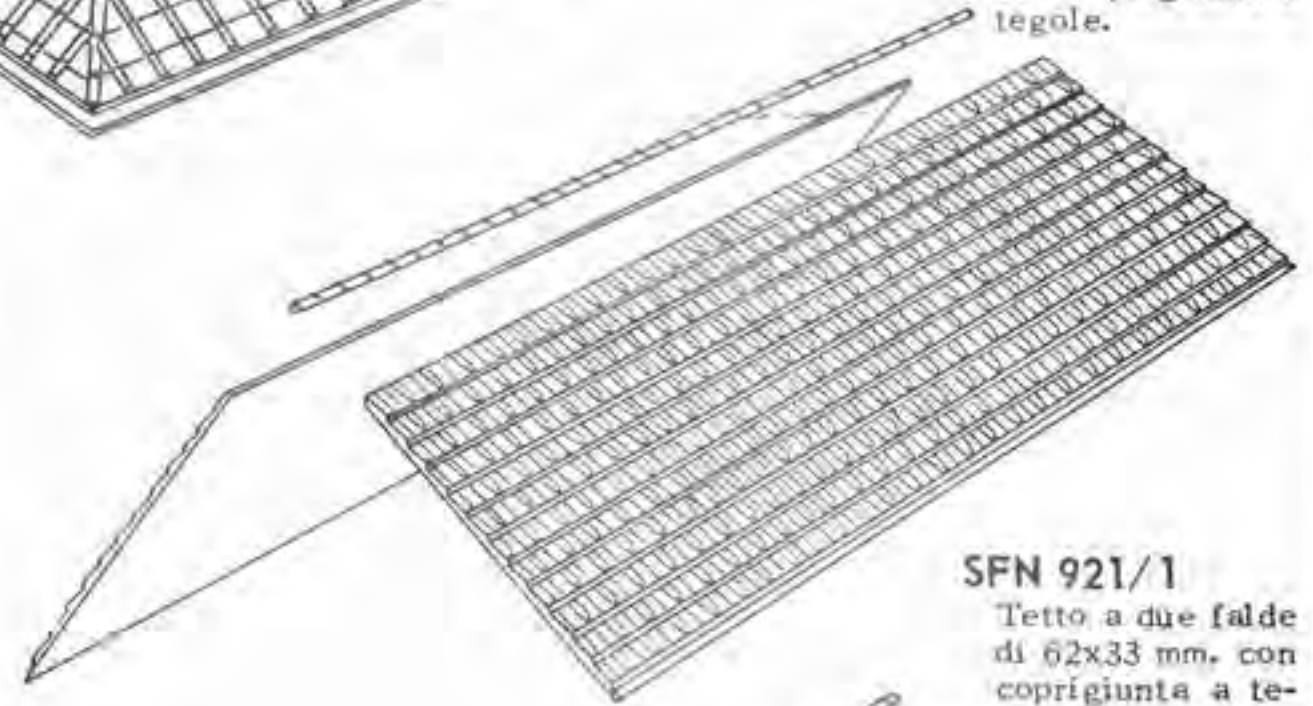

SFN 921/1

Tetto a due falde di 62x33 mm. con coprigiunta a tegole.

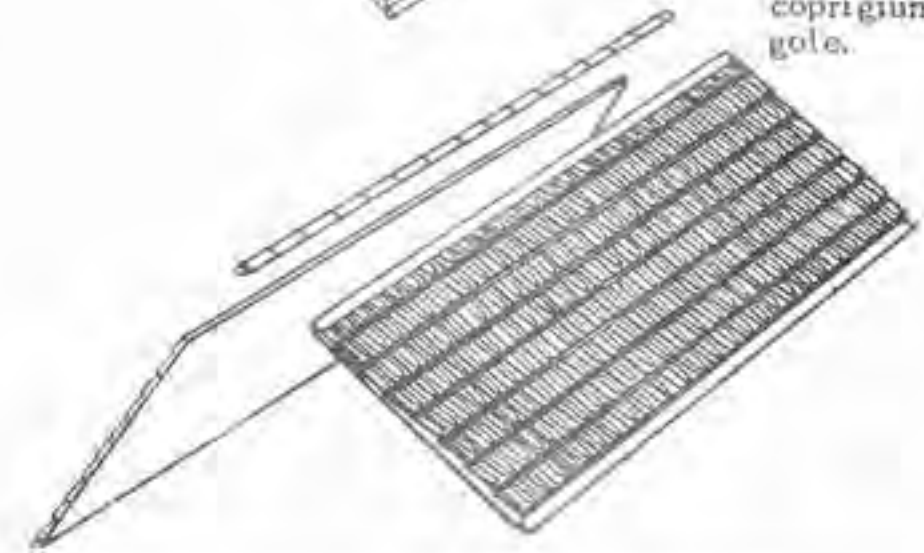

Sigla	pezzi per confezione	Prezzi al pubblico in Lit. per confezione	
SFN 915	1	Cad.	310
SFN 921/1	1	*	160
SFN 921/2	1	*	235
SFN 909	12	* Conf.	180/12
SFN 911	12	* *	180/12
SFN 908	12	* *	180/12

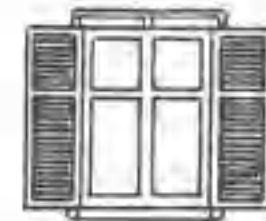
SFN 909  
PortaSFN 911  
finestra  
chiusaSFN 908  
finestra  
aperta

LOCOMOTIVA L B&O/R		
Sigla	Pezzi per confezione	Prezzi al pubblico in Lit. per confezione
SFN 1079/B&O	1	Cad. 2,200
SFN 1084	1	" 600
SFN 1051	1	" 400
SFN 1125/N	2	" Conf. 250/2
SFN 1127/N	2	" " 300/2
SFN 1113	2 serie	" " 120/2
SFN 1105	6	" " 60/6
SFN 964	12	" " 120/12
SFN 962	12	" " 120/12
SFN 1047	6	" " 120/6
SFN 1104	6	" " 120/6
SFN 1108/N	12	" " 96/12
SFN 823	6	" " 1.800/6
SFN 740 A	6	" " 300/6
SFN 1089	6	" " 180/6
SFN 1121	6	" " 360/6
SFN 635	12	" " 180/12

**SFN 635**  
fanale anteriore trasparente

**SFN 1084**  
Carrozzeria con boccola filettata nel camino

**SFN 1051** telaio in nylon completo di piastrina e vite

**SFN 1079/B&O**  
motore con vite senza fine

**SFN 740 A** spazzola rame per motore SFN 1079

**SFN 1089** molla per spazzole

**SFN 1104**  
gancio posteriore

**SFN 823**  
lampadina 12 V. Ø 3 mm.

**SFN 1127/N**  
asse con ruote nere Ø 15 mm. e ingranaggio

**SFN 1108/N**  
vite autofilettante

**SFN 1125/N**  
asse con ruote nere Ø 15 mm. senza ingranaggio

**SFN 1113**  
molletta prendicorrente con capocorda, vite e dado fissaggio.

**SFN 964**  
vite 2x7,5

**SFN 962**  
vite 2x4,5

**SFN 1105**  
biella di accoppiamento

**SFN 1047** gancio anteriore (anche per L 835/R)